

# COMBAT SOPs

## Rifle Platoon I

Edited by  
1stLt. B.B. McBreen USMCR

**Project Leatherneck**  
Camp Pendleton, California  
December 1992

This publication is part of **Project Leatherneck**, a collection of training aids, references, and research, aimed at improving the combat readiness of the Infantry Battalion.

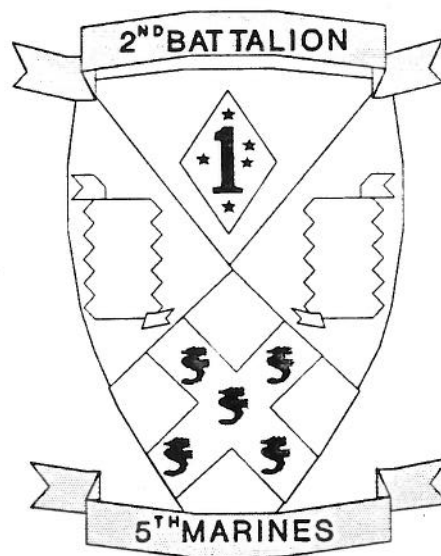

If you have any ideas on how to improve this publication, or would like to put your name on the **Project Leatherneck** catalog, please contact:

**Training and Operations**  
**2d Battalion, 5th Marines**  
**Camp Pendleton, California 92055**  
**(619) 725-7884**

# Contents

Preface.....v

## Anti-Tracking

- Technique (A) Stay Behind Ambush
- Technique (B) Buttonhook Ambush
- Technique (C) Angle Technique
- Technique (D) Box Technique
- Technique (E) Dog Leg
- Technique (F) Figure Eight Technique
- Technique (G) Skip Technique
- Technique (H) Step Technique

## Break Contact

- Australian Peel

## Danger Area

- Technique (A) Linear Technique
- Technique (B) Bump and Run
- Technique (C) Cross Compartment

## Defensive Positions

- Cigar-Shaped Perimeter
- Harbor Star
- Platoon Triangle Perimeter
- Platoon Patrol Base Occupation
- Squad "Hedgehog" Perimeter
- "Y" Defense

Gear

- Gear (A) Squad Leaders**
- Gear (B) Fire Teams**
- Gear (C) Every Marine**
- Gear (D) Techniques**
- Gear (E) Equipment for Special Teams**

Hand and Arm Signals

- Hand and Arm Signals I**
- Hand and Arm Signals II**

Linkup Operations

- Linkup SOP**

Movement

- Jungle Movement Technique**

Search and Reconnaissance

- Box Recon**
- Box Security Patrol**
- Heart-Shaped Recon**
- Malaysian Fan**
- Zig-Zag Recon**

Weapons

- Weapons SOPs (A)**
- Weapons SOPs (B)**

Ambush

- Squad Linear Ambush**
- Occupation of Squad Linear Ambush**
- Execution of Squad Linear Ambush**



# Preface

**COMBAT SOPs: Rifle Platoon I** are the standard operating procedures practiced by 3d Platoon, Echo Company, 2d Battalion, 5th Marines, as of June, 1992.

Any unit SOP should be developed to meet the specific mission, abilities, and training level of that unit. Additionally, a unit SOP should be constantly evolving and improving. This collection can be thought of as a snapshot of the Platoon SOPs in practice as of June of 1992. Most of the SOPs were developed in the jungles of Okinawa, and apply to independent, patrol base operations. There are no MOUT, vehicle, Armor, or Mechanized vehicle SOPs.

As a platoon commander, I had each squad leader, the platoon guide, and the platoon sergeant, keep a three-ring binder of unit SOPs. After each field exercise, we went over each SOP and made pen changes based on lessons learned during the operation. New SOPs could be proposed by any member of the command. Small-unit leaders were held responsible for training their Marines on the specifics of each SOP. Because the SOP was not carved in stone, it constantly improved with the contributions and arguments of Marines and NCOs.

This collection is a reference. Along with Company SOPs, Battalion SOPs, Field Manuals, professional publications, and combat narratives, it is intended to help you in developing your own platoon SOPs.

Photocopying is encouraged.

B.B.M.

# Stay Behind Ambush

To ambush trackers.

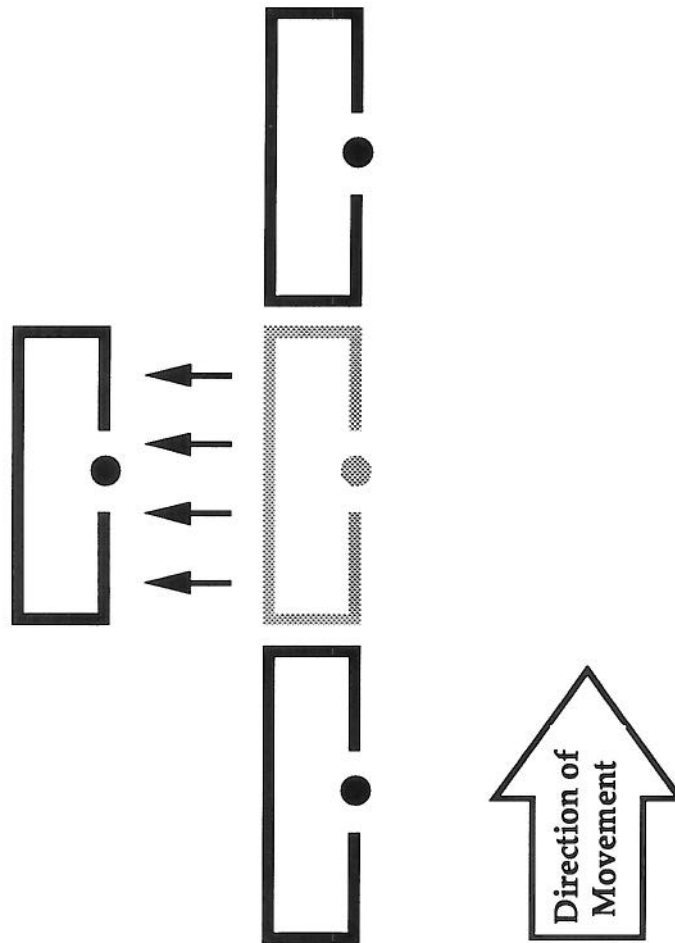

## Notes:

1. Unit believes it is being followed. Second element selects good ambush position to one side of unit's path.
2. Unit leader specifies a **distance, direction** and **time** for the main body to move: "We'll move 200m at this 28° azimuth and wait one hour."
3. Main unit moves on, stay behind element waits to ambush trackers.
4. After one hour, stay behind element rejoins main body.
5. If contact occurs, main body reinforces ambush. Unit should move far enough to lure trackers on, but not so far as to be unable to quickly reinforce ambush.
6. Second element is used for ambush because enemy may have eyes on tail element and lead element is navigation element.
7. Unit should be dropped off around a bend or over a hill or in other areas less likely to be seen by trackers. Main unit should not stop moving.

# Buttonhook Ambush

To ambush trackers.

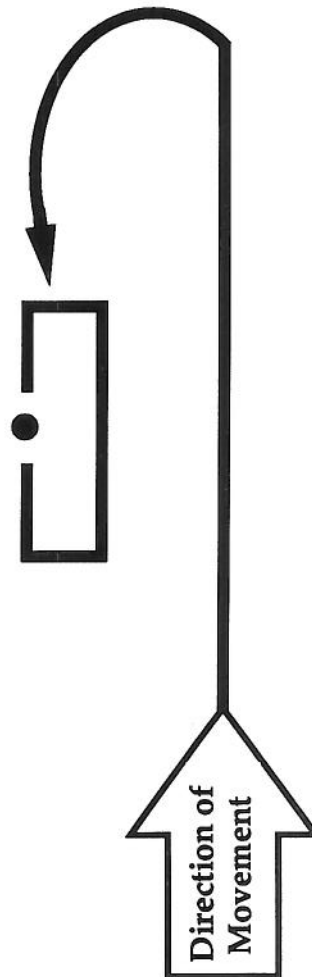

1. Unit believes it is being followed. Executes **Buttonhook Ambush** : reverses direction and sets ambush to cover its own path.
2. Unit uses Ambush SOPs to execute ambush and withdraw.
3. In thick jungle, buttonhook will be two 90° turns very close together. Ambush site should be selected on first pass, NOT on buttonhook.

# Angle Technique

For increased security: to make it difficult for unit to be tracked.

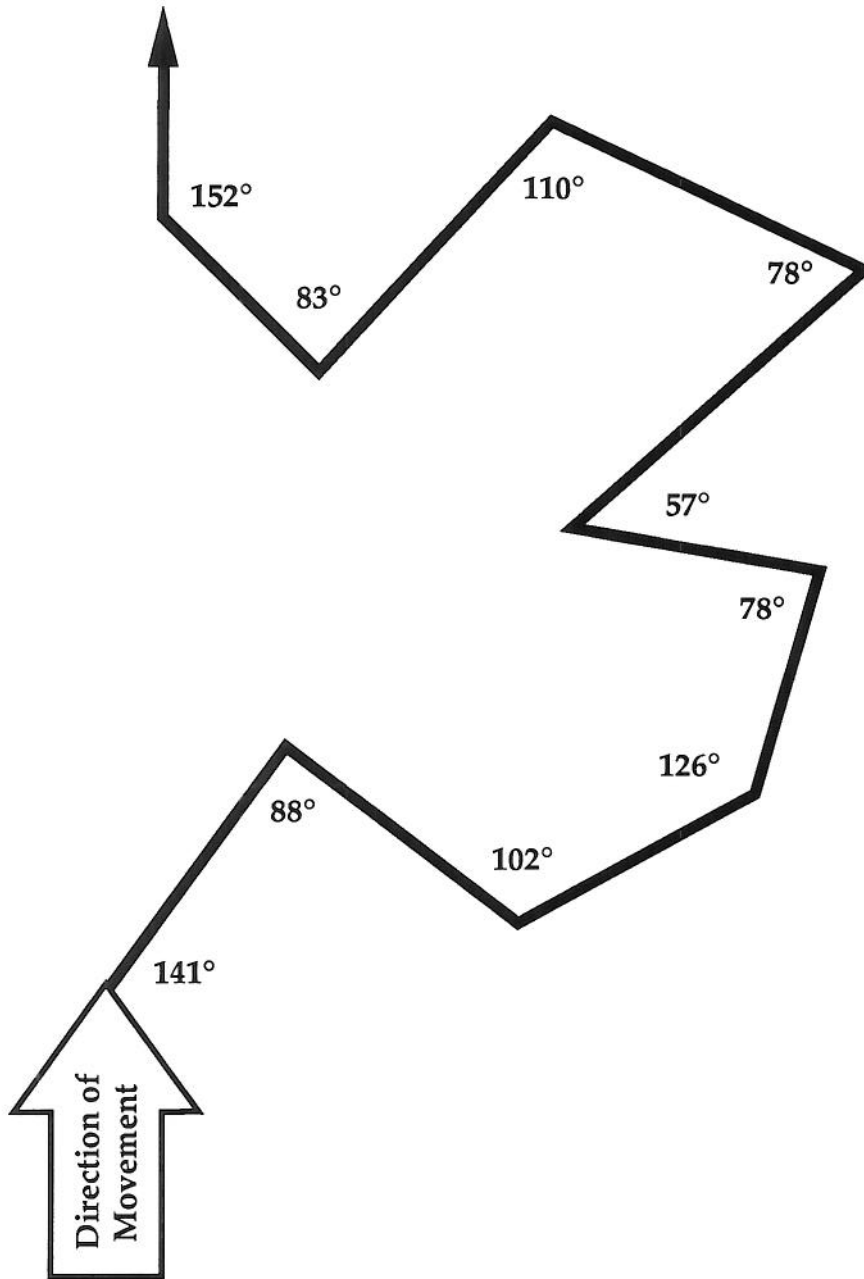

**Notes:**

1. Navigator calculates erratic path for dead reckoning. Probability of navigation errors increases.



# Box Technique

For increased security: to make it difficult for unit to be tracked, and easier for trackers to be counterambushed.

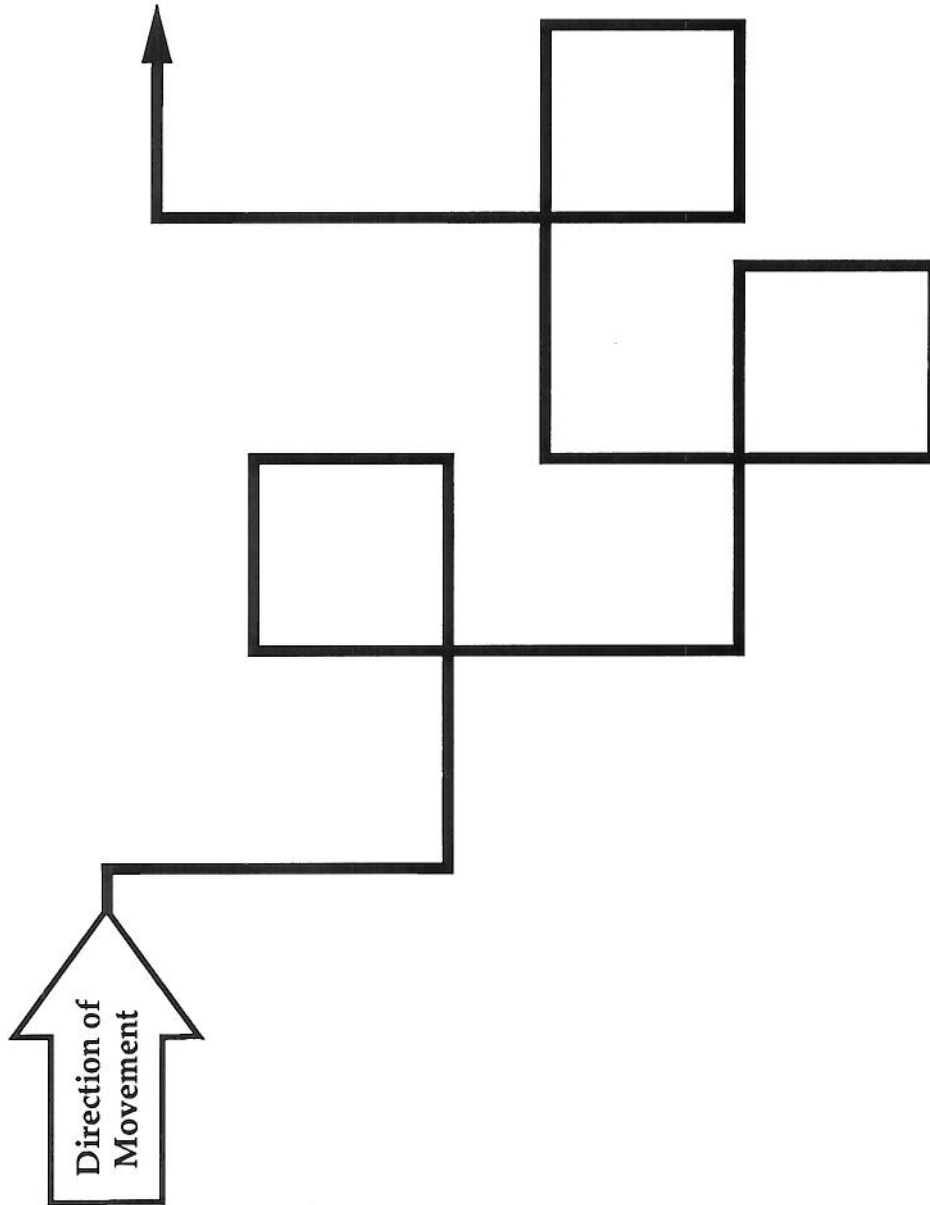

## Notes:

1. Difficult to keep track of navigation, but correspondingly difficult for trackers.
2. Options at each junction: cross path, walk backwards on old path, examine path for signs of trackers, or set in ambush.

# Dog Leg

For Patrol Base and ORP selection: To confuse trackers and maximize security.

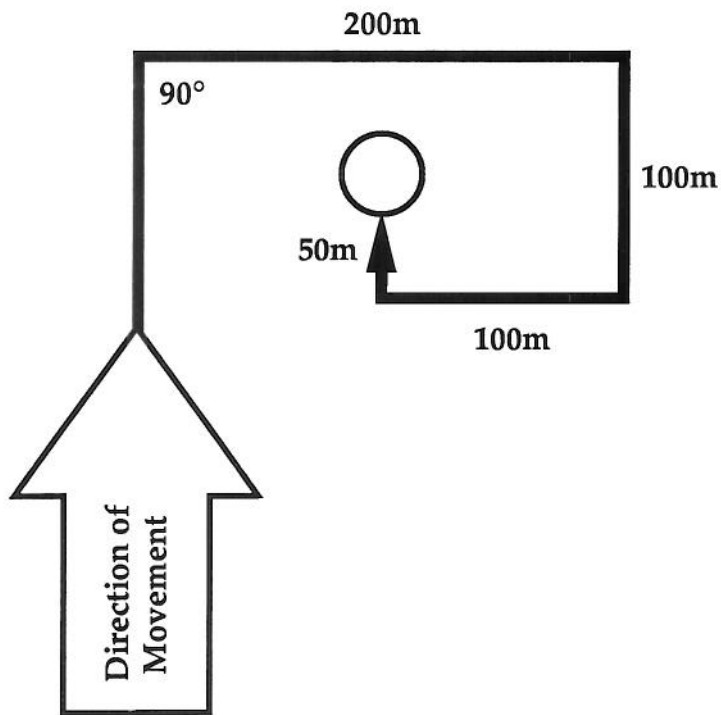

## Notes:

1. Column stops. Lead element reconns patrol base or ORP: Dog Leg and Heart-Shaped Recon.
2. Four corners are not required. Depending on time, terrain and threat, unit leader can place unit after one, two or three corners.
3. Centering unit inside its own tracks insures that unit is alerted when trackers move around it. Trackers moving perpendicular to perimeter are more vulnerable to fire from perimeter.
4. OP/LP and claymore should be placed at 6 o'clock. Additional claymores can cover other legs. Claymores should be place so that they fire perpindicular to the perimeter.

## Figure Eight Technique

For increased security: to make it difficult for unit to be tracked, and easier for trackers to be counterambushed.

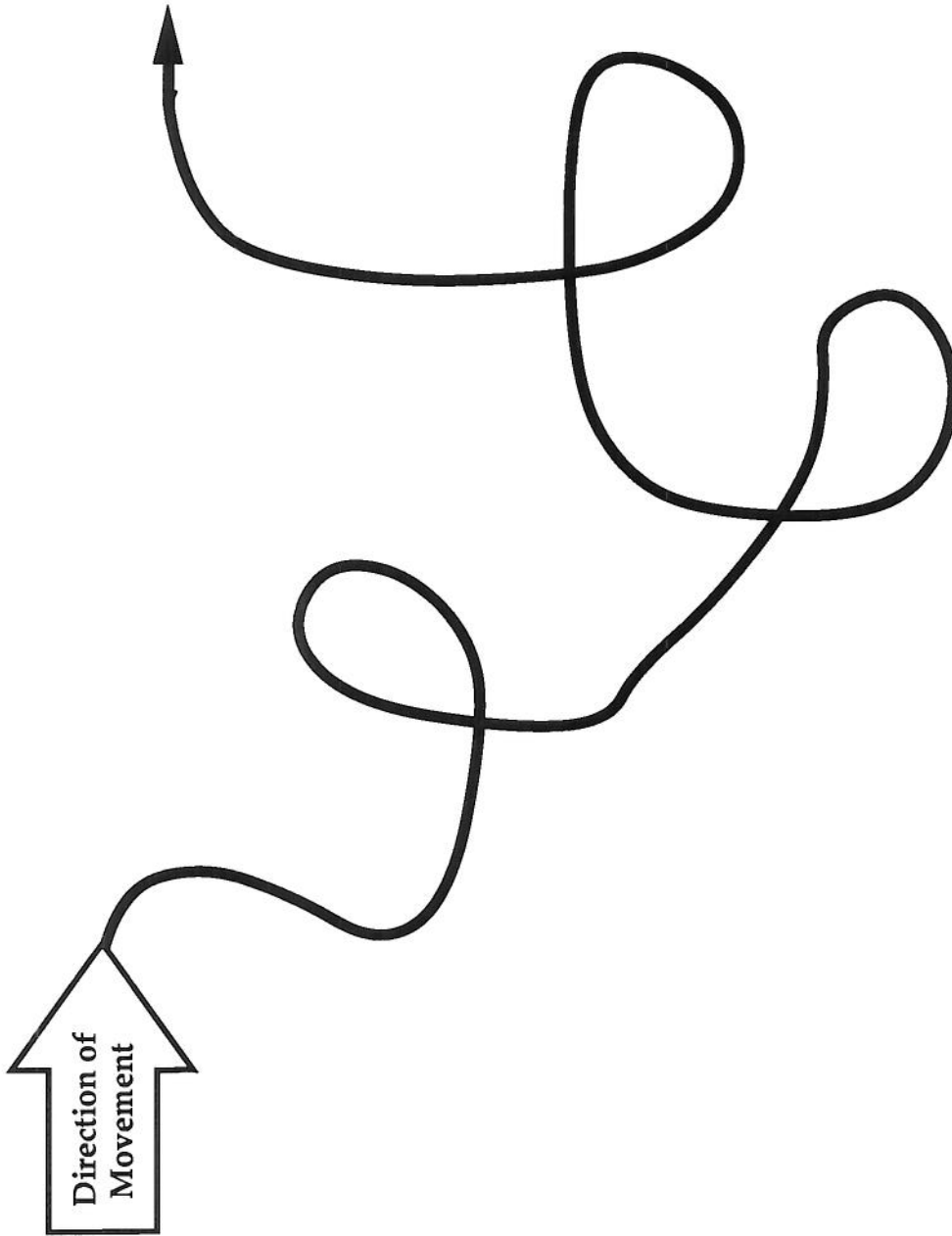

**Notes:**

1. Same as Anti-Tracking Box Technique. Impossible to do when dead reckoning.
2. Options at each junction: cross path, walk backwards on old path, examine path for signs of trackers, or set in ambush.

# Skip Technique

For increased security: to make it difficult for unit to be tracked.

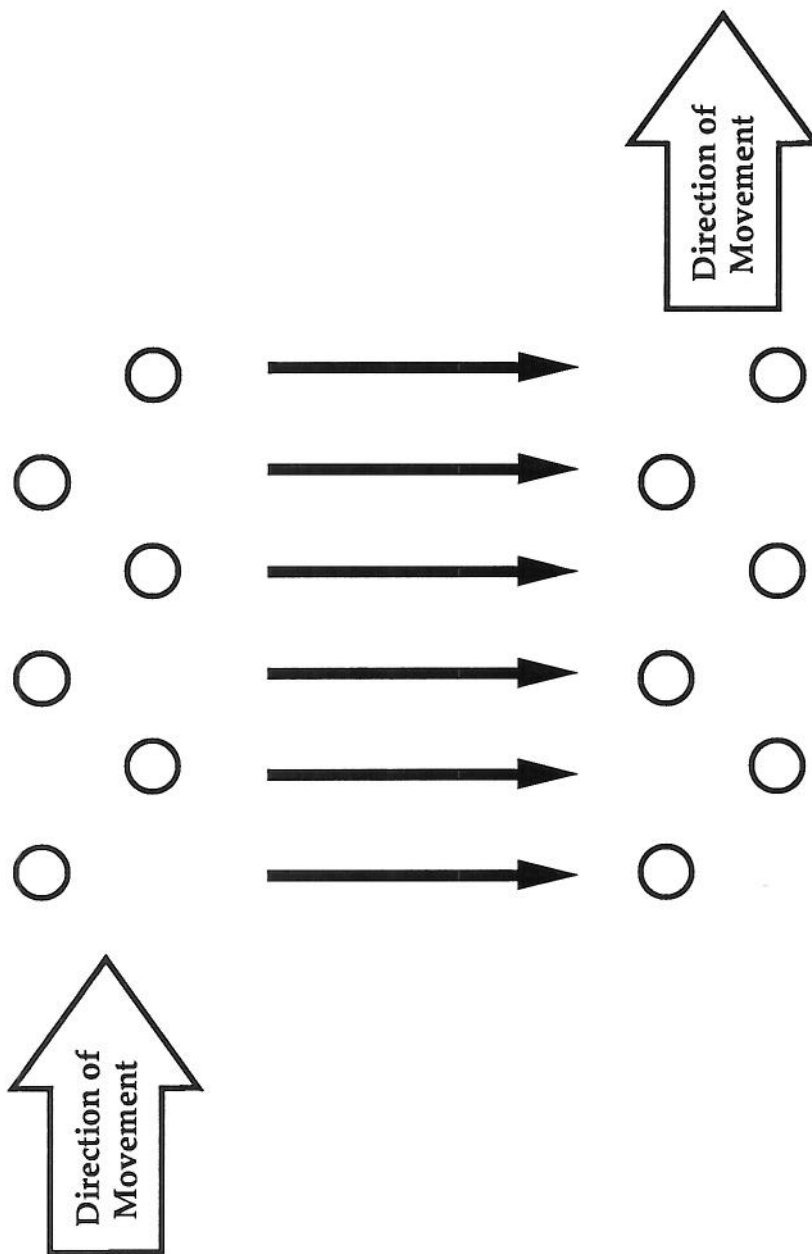

**Notes:**

1. Column Stops. Each man moves right fifty (50) meters. Column continues.
2. Point man should go forward to create false track.
3. Direction (left or right) and distance skipped can be varied on a continuous basis.

# Step Technique

For increased security: to make it difficult for unit to be tracked.

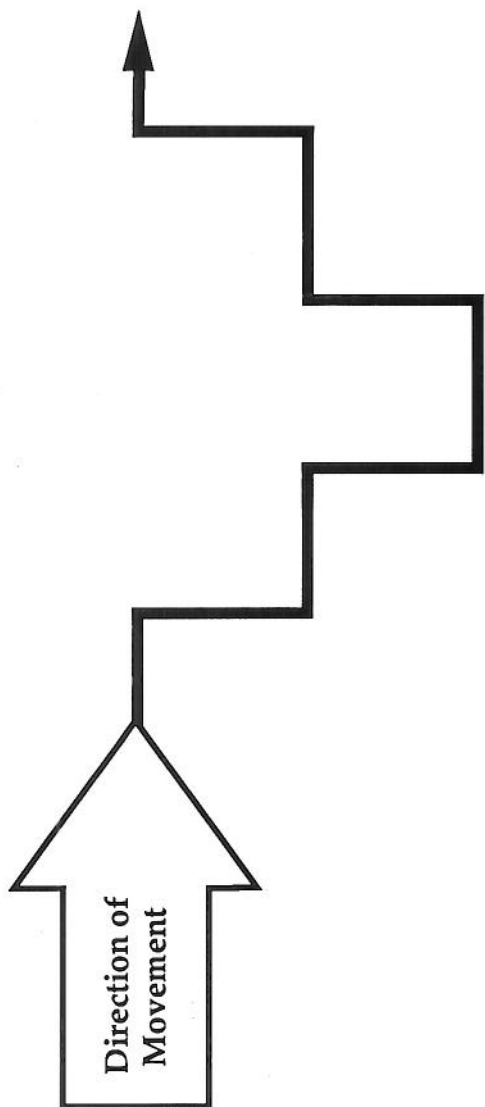

**Notes:**

1. Each leg is the same length, each corner is 90°. Navigator must keep track of number of offsets.

# Australian Peel

"Break Contact"

For breaking contact when point of column is hit.

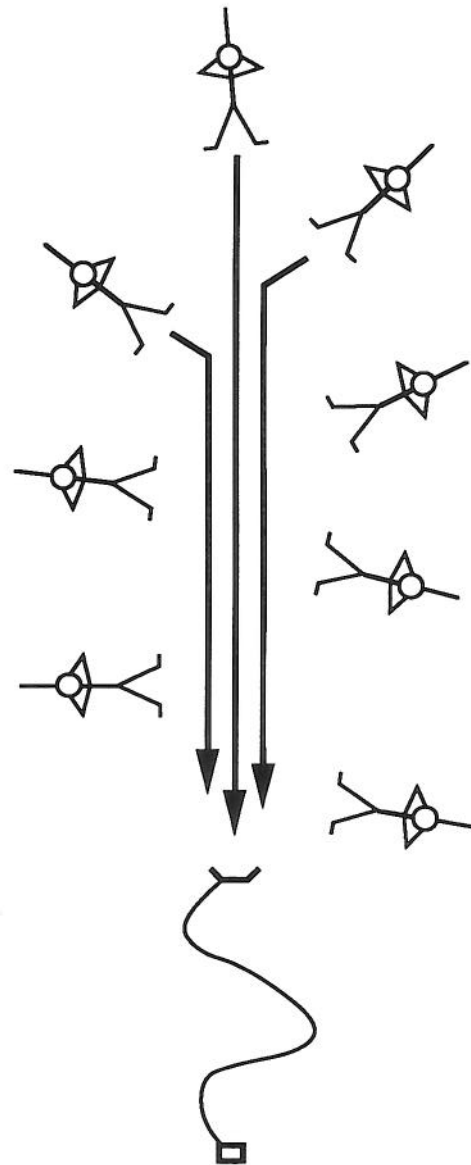

## Notes:

1. Point makes contact. Lead man fires one magazine on burst, throws a grenade, and runs to the rear of the squad.
2. Men move down center to avoid fire from flanks.
3. Second man fires to cover pointman's movement, throws grenade and runs.
4. Sequence is repeated down the column.
5. Last man sets up claymore.
6. Men moving back bring any wounded, report size and location of enemy to patrol leader.
7. When moving as platoon, lead squad peels back to move into hasty platoon position. Platoon can then break contact by bounding
8. Patrol members should be briefed during rehearsals if patrol is to react to all contact in this manner. A recon patrol order may state, "We will break contact on any enemy contact."

Danger Area

Technique (A)

# Linear Technique



To Cross a Linear Danger Area

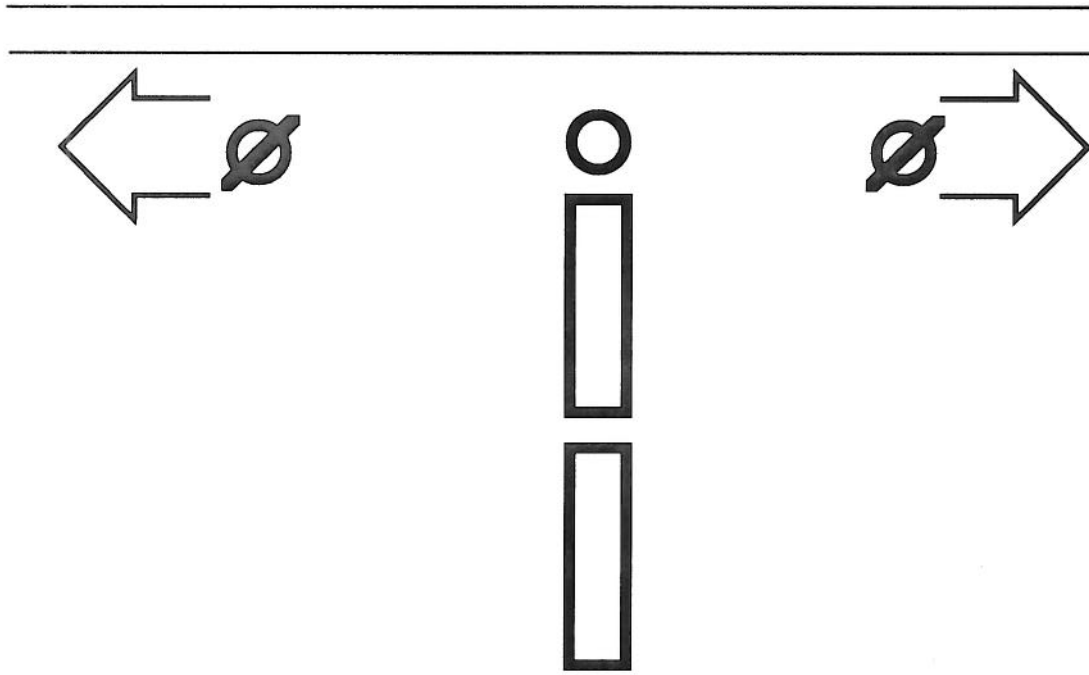

1. Column stops. Signal is passed, "DANGER AREA." Security Element sets out flank security, sends team to recon far side. ZIG-ZAG recon for Cigar-Shaped Perimeter. Team signals back, "ALL CLEAR."
2. HQ element crosses, followed by support element if present, then assault element. Unit forms Cigar-Shaped Perimeter.
3. Last man of assault element is responsible for signalling the flank security teams. Flank security teams cross, move to front of column. Element leaders notify PL when all their people are across.
4. Perimeter should NOT be used to rest. Move out as soon as possible.
5. Unless changed by order, rally points are 200m in front of, and 200m behind danger area.

Danger Area

Technique (B)

# Bump and Run

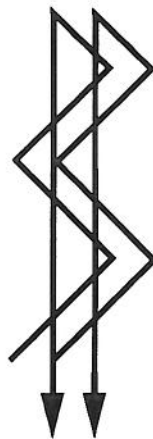

To Quickly Cross a Linear Danger Area

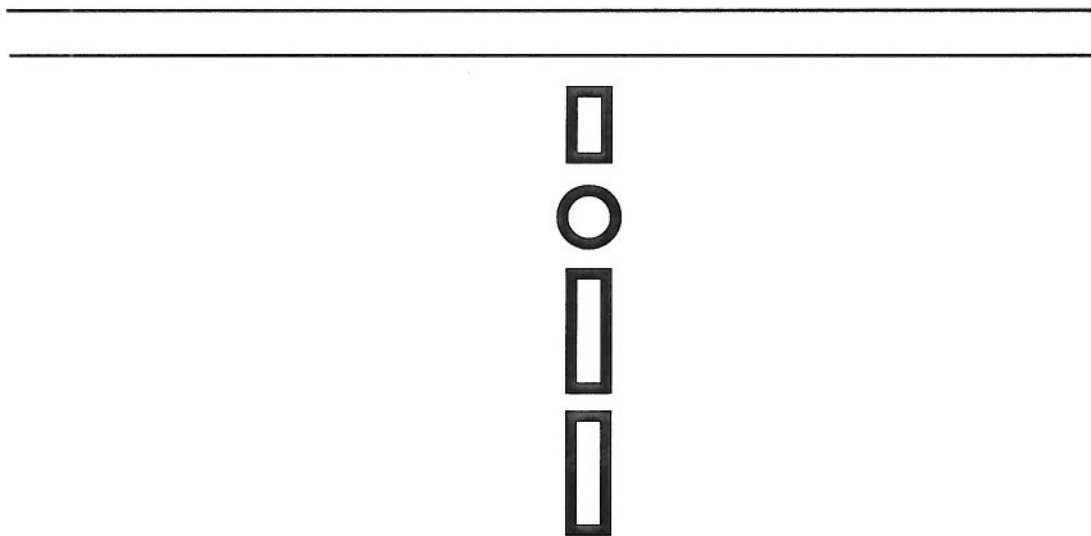

1. Column stops. Signal is passed, "**DANGER AREA**": Hand slashes throat. Security Element sends team to recon far side. Zig-Zag recon for Cigar-Shaped Perimeter. Team signals back, "**ALL CLEAR**": Thumb Up.
2. First man on near side covers one direction of danger area. Second man approaches, covers opposite direction, and 'bumps' first man. First man crosses and takes position on far side, **STILL COVERING THE SAME DIRECTION**. He 'bumps' the far side security man.
3. Procedure is repeated one man at a time. Three men cover the road at all times.

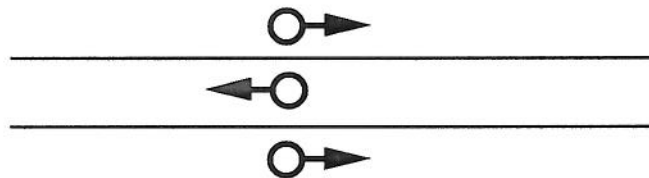

4. Patrol **DOES NOT STOP** - Speed is security. Patrol does not re-organize on far side because the order of movement was not changed.
5. If speed is absolutely essential - breaking contact, withdrawing from ambush - zig-zag recon of far side can be skipped.
6. Unless changed by order, rally points are 200m in front of, and 200m behind danger area.



Danger Area

# Cross Compartment

To move across a cross compartment danger area.

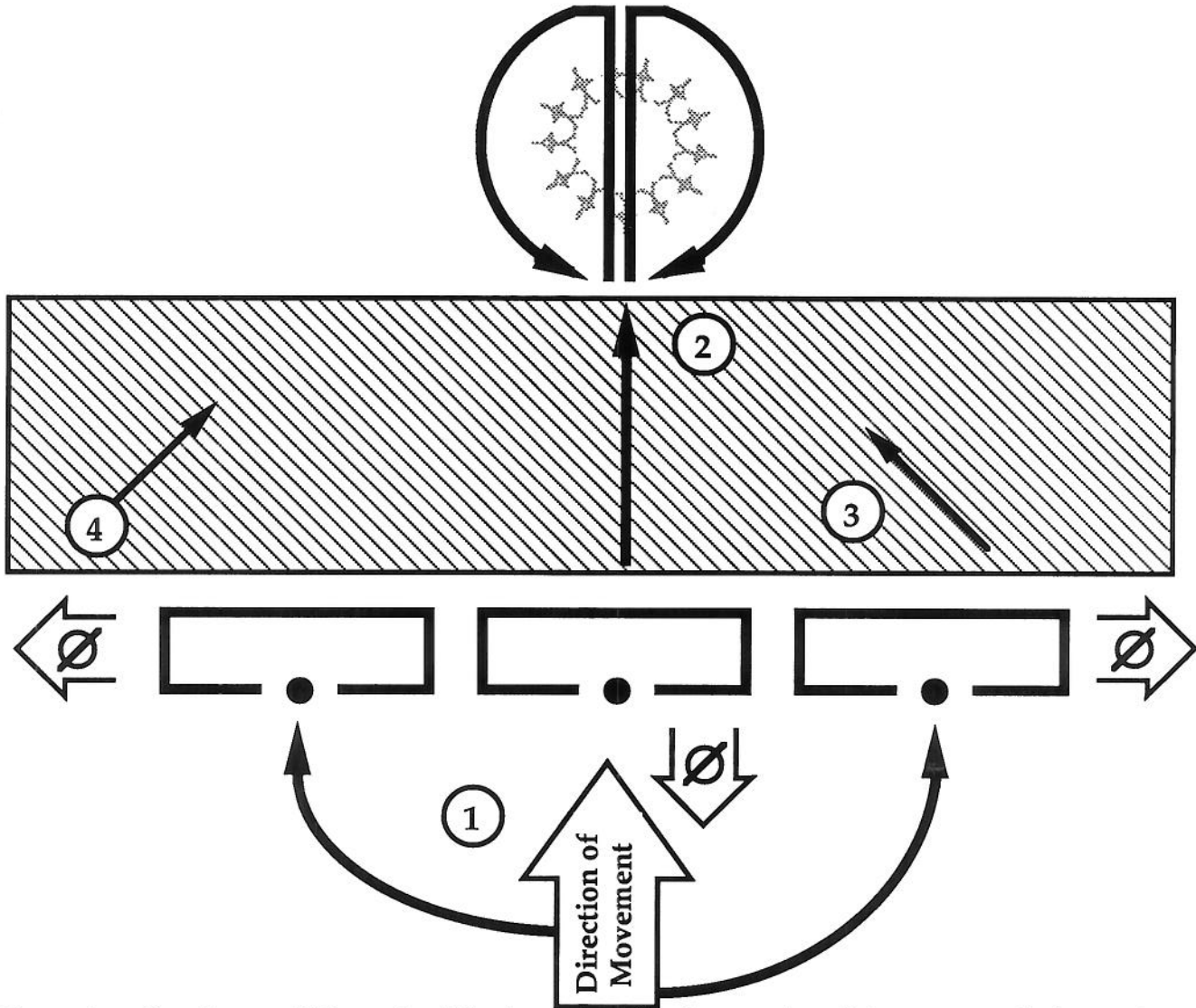

1. Column stops. Signal is passed "Danger Area": Cutting motion of hand across throa Point man or unit leader signals "On Line": Both arms (or one arm) extended outboard, parrallel to deck. Unit deploys 2-1-3. Leftmost fire team is left flank security, rightmost fire team is right flank security, trail fire team of lead squad is rear security.
2. Point fire team crosses Danger Area. Conducts Heart-Shaped Recon for unit perimeter. Signals "All Clear": fist with thumb up. May have to recross Danger Area somethat to signal. Point and Slack men establish "door" for perimeter.
3. Signal ispassed to the right-most squad. Unit begins to cross by teams from right to left. First team to cross is the team just inside the right flank security team. As each team crosses, it signals the team to its left.
4. When the left flank security team gets the signal, there should be only three teams left - the security teams. As the left flank security team crosses, it signals the remaining two teams. "••" "••" (YES, YES) A noise signal should be used because the security teams are focused outboard, not inboard. Rear security team crosses followed by right flank security team. Right flank security team is also the rear team of the column. When it arrives at the perimeter, it replaces the Point and Slack men at the 6 o'clock door. Element leaders should notify the patrol leader when their people are all across.

#### Notes:

- A. Small Danger Areas should not be crossed - go around. The perimeter on the far side should not be used to rest. Get out of there as soon as possible. Headquarters element crosses on their turn - either before or after the team from the center squad.
- B. Unless changed by the order, near and far side rally points are 200m behind and forward of the near and far edges, respectively. If unit is split, men at rally point where unit leader is will move to other rally point.

# Cigar-Shaped Perimeter

For all-around defense during short halts.

## Notes:

1. Column stops. Signal is passed, **Cigar-Shaped Perimeter** : Right hand thumb to mouth. Column tightens up and sets in.
2. Last man is rear security.
3. At night or in close terrain, dispersion can be tightened so that men across from each other can touch feet, sole to sole.
4. Squad Leader at 10 o'clock to standardize with Perimeter SOP.

## Pros:

1. Fast and easy. Patrol column positions are maintained. Easy to move out.
2. Good firepower to the flanks.

## Cons:

1. Communication and control. Leader typically cannot see or communicate with entire perimeter. Teams are split.
2. Little fire power to the front and rear.

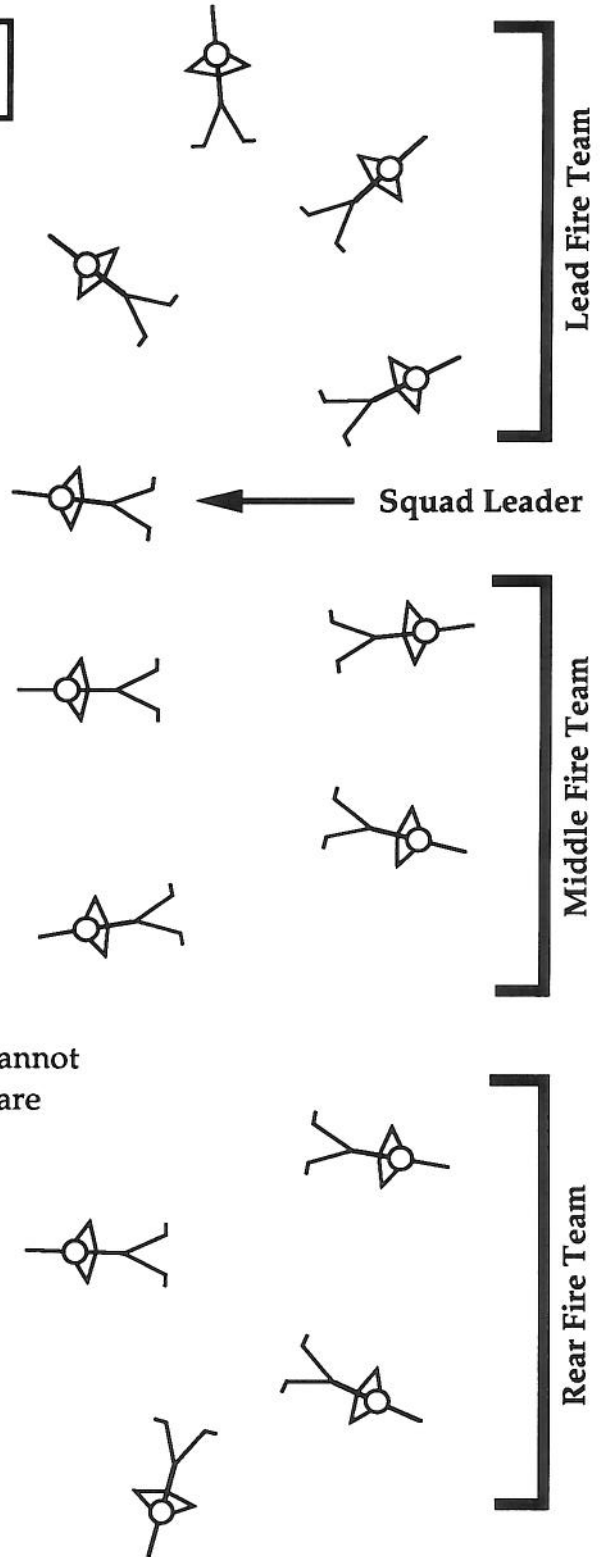

# Harbor Star

For units smaller than a squad. To rest and refit for short amount of time.

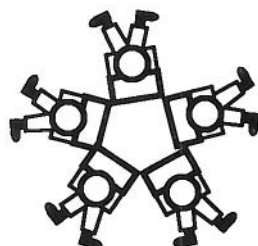

1. Signal is passed, "**HARBOR STAR**" : Index finger makes circle towards sky (same as **ASSEMBLE**).
2. Team stops, sits in a circle facing outboard.
3. Radio handset is passed to man on watch while remainder of unit sleeps.

# Platoon Triangle Perimeter

For Platoon Patrol Base, ORP, Assembly Area, or defense of a specific location.

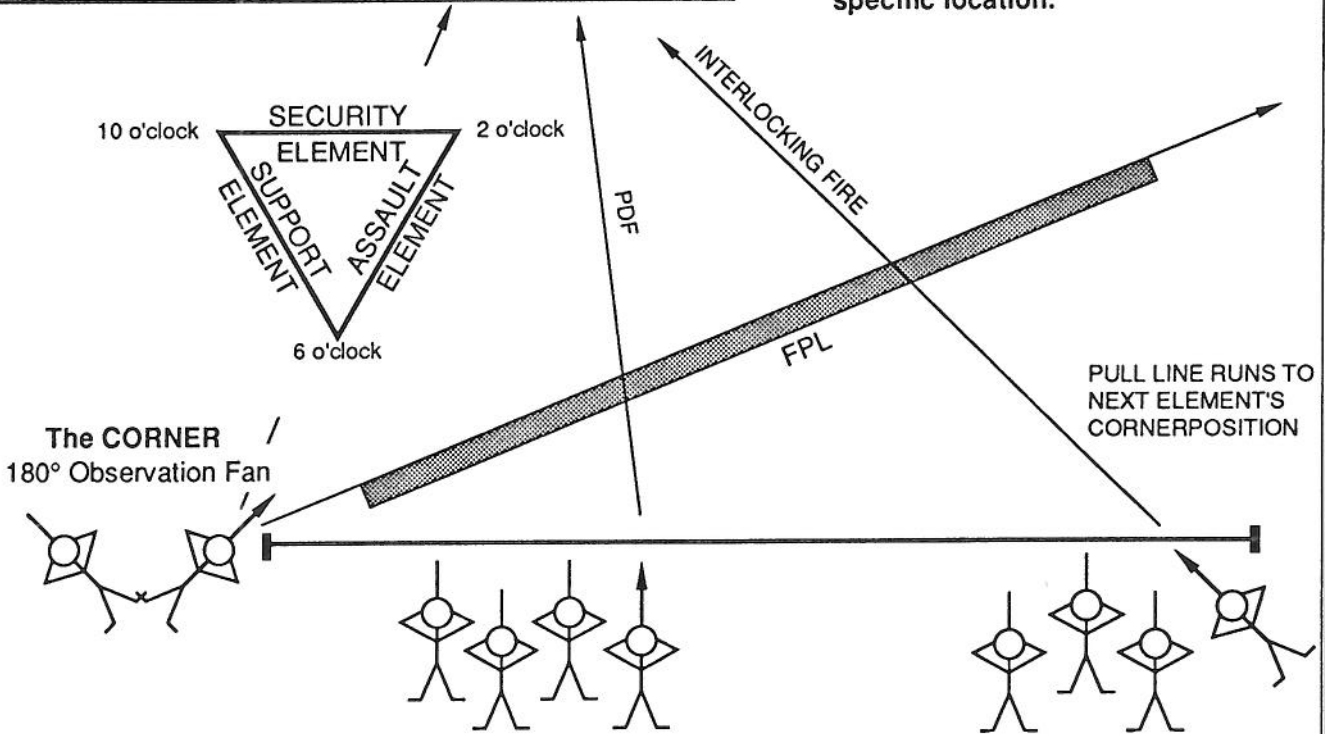

1. The three platoon elements are formed in a triangle, with corners at 2, 6, and 10 o'clock. The frontage of each element is defined by a length of comm wire. This pull line allows communication between each corner position and also helps define fields of fire when setting up in the dark.
2. **The Corner position is always manned.** Two men, ankles crossed, offset by 90°, provide a 180° field of observation. When an entire element leaves the patrol base, another element provides the two-man corner. The triangle perimeter can be manned by as little as six men, two at each corner. As men leave or sleep, security is maintained by the corner positions.
3. The right-hand man of the Corner fires an FPL across the element frontage. Priority of automatic weapons goes to this position. Additional automatic weapons can shoot interlocking fire from the right side or a PDF on likely avenues of approach.
4. When positions are dug-in, CORNER positions can have frontal cover, while still maintaining their enfilading fields of fire.
5. Claymore priority is: (1) DOOR at 6 o'clock, (2) CORNERS at 10 and 2 o'clock, (3) Other Positions.
6. This perimeter plan assumes fairly level ground with no distinctive terrain. Terrain and enemy situation should dictate modifications to this plan.
7. Compared with standard circular perimeters, with automatic weapons facing outboard like spokes of a wheel, this perimeter plan has far better weapons coverage. It also collapses in an orderly manner. As men leave on patrol, the perimeter still maintains its firepower integrity.

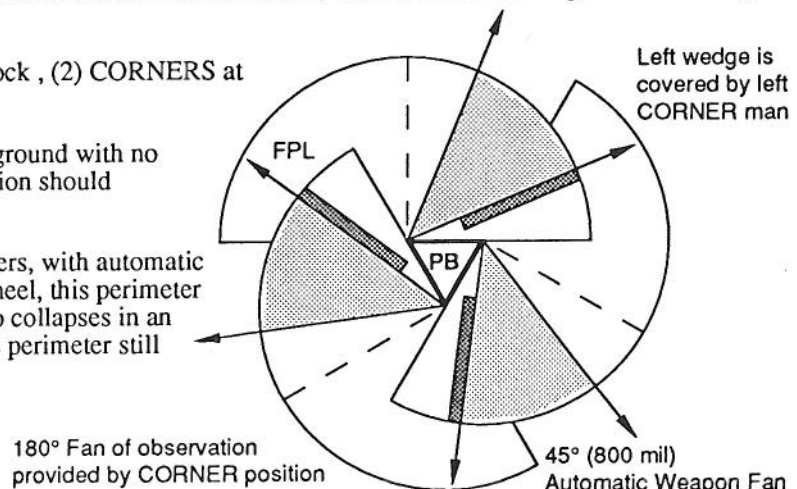

Schematic of Coverage

# Platoon Patrol Base Occupation

See 'Platoon  
Triangle Perimeter'

1. HALT Unit. Form Cigar-Shaped Perimeter.
2. ORDERS GROUP UP, APL receives 5-point contingency plan.
3. LEADER'S RECON - (5) men: PL, security man, and (3) element leaders.  
Each element leader carries a perimeter wire.  
Recon group carries at least (2) compasses.
  - A. DOG LEGS - Recon group dog legs into tentative PB site.
  - B. CLOSED-BOX (HEART-SHAPED) RECON.
    1. Select center of PB, split up, do box around center, 100m x 100m at minimum.
    2. Link-up at 6 o'clock position. Element leaders start to set in wire perimeter, PL and security man leave packs in center, return to unit.
    3. When perimeter wires are set in, Element leaders set up HARBOR STAR at 6 o'clock.
4. PL and security man lead unit up, set in TRIANGLE PERIMETER.
  - A. Movement and Occupation
    1. Security man leads unit to 6 o'clock position, halts unit.
    2. Security man kneels at 6 o'clock, monitors men entering perimeter.
    3. (2) men enter perimeter at a time, are assigned positions by element leader, immediately drop packs and get into position.
    4. Security man waits until perimeter is quiet, previous men are in position, then lets (2) more men in.
    5. Element leaders place men, then move to their left corner position.
    6. HQ element is positioned in center.
  - B. Listening Halt and Stand-To
    1. Security man lets last men get into position, then gives Stand-To signal: **long, low whistle**.
    2. Unit listens for (4) minutes of dead silence.
    3. Stand-To lasts 20 minutes. Each unit is at 100% alert. Element leaders coordinate fields of fire, PDFs, FPFs, dead space, claymore positions and security schedule.
    4. Orders group meets in center (30) minutes after stand-to signal.

# Squad "Hedgehog" Perimeter

For all-around security during long halts: Assembly area, ORP, Patrol Base, or defense of a specific location.

HQ Element:  
Squad Leader,  
and Corpsman  
and Radio  
Operator, if  
present, at 10  
o'clock

Lead Fire Team

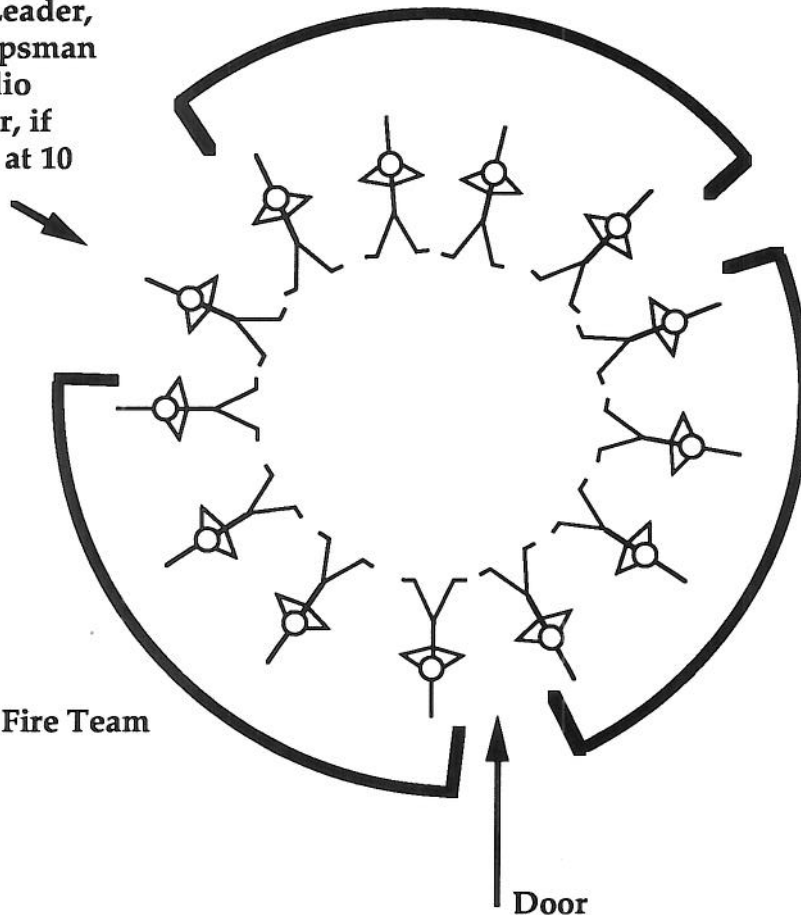

Last Fire Team

Middle Fire Team

Door

## Notes:

1. Signal is passed, "PERIMETER": Right hand grabs blouse in center of chest.
2. Usually a dog-leg and a heart-shaped recon should be done before occupying the perimeter.
3. When moving in (or out), only ONE man should be standing inside perimeter at one time.
4. Center area can be used by radioman and squad/patrol leader. With so small a unit, however, each man should have a position in the perimeter: Maximize weapons outboard, Minimize silhouette of unit. Squad leader plus radio operator can act as reserve to reinforce threatened area.
5. Dispersion can be adjusted by the squad/patrol leader. In the dark, each man should be able to wake his neighbors. Toes should be touching when feet are spread.
6. Door is at 6 o'clock. No one should leave perimeter after dark. (Head calls INSIDE)
7. If only one claymore is set out (by 3rd team), priority should be 6 o'clock to cover trail.
8. If two-man OP/LP is set out (by 3rd team), priority should be 6 o'clock for door security.
9. The direction and distance to the rally points should be known by each man. Compasses should be set with either the primary or secondary rally point azimuths.
10. Occupation: Point Man sets in at 2 o'clock. Each man following sets in to the left of the man in front of him, making a counter-clockwise circle.
11. Evacuation: Point Man moves out. Each man follows the man to his right. Perimeter "unwinds" in a counter-clockwise circle.



## "Y" Defense

For all-around security during long halts.  
To defend a key piece of terrain.  
To execute a triangular ambush.

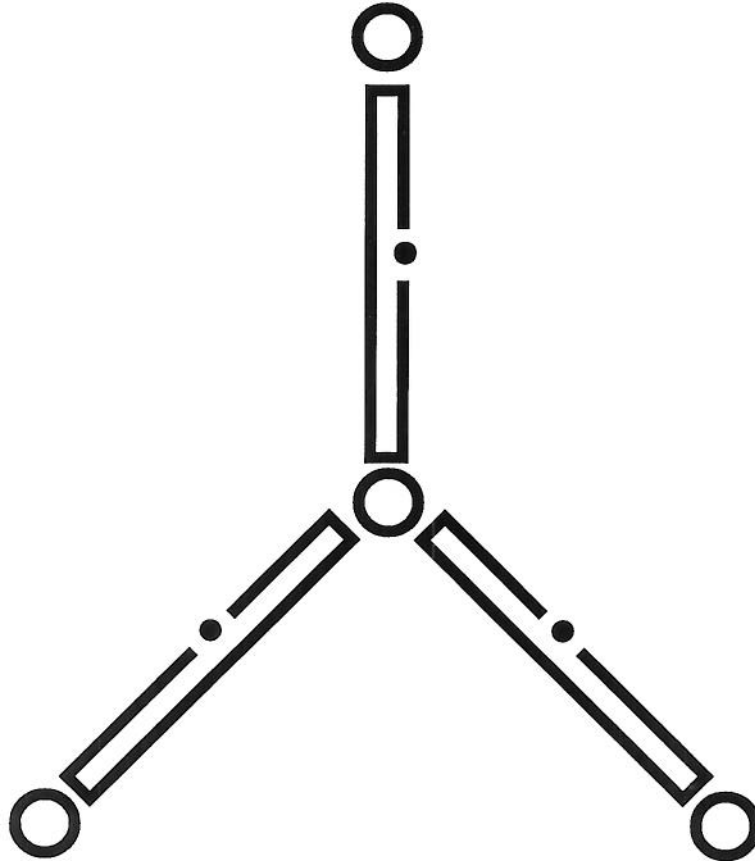

### Notes:

1. Fire can be massed in three separate kill zones. By reversing positions, each leg can fire into two of the three zones.
2. Unit not engaged has covered route into center to reinforce.
3. Machine Guns can be positioned either in the center, where they would have three separate 120° fields of fire, or at the end of any leg, where they would have a 240° field of fire.

### Pros:

1. Difficult for enemy to determine size and layout of defending unit.
2. Superior to perimeter defense in potential ability to mass fires.
3. Position is over-runnable. Defensive fires can rapidly shift to new kill zone.
4. Unit leader in center can communicate rapidly with all three elements.

### Cons:

1. Dangerous. Fields of fire must be carefully coordinated to avoid friendly casualties.

## **Gear (A)**

**In the field, Squad Leaders will carry:**

1. Map, protractor, and map pen.
2. Cloth tape.
3. Pull wire with handles.
4. Compass.
5. Whistle.
6. Red Lens Flashlight.
7. Cammie Paint.
8. Pen, Pencil, and Notebook in Zip-Lock Sandwich Bag.
9. Watch.



## **Gear (B)**

**In the field, Fire Teams will carry:**

1. Red Lens Flashlight. Three uses: Signalling, Reading a Map, and Treating Casualties.
2. Cammie Paint.
3. Pen, Pencil, and Notebook in Zip-Lock Sandwich Bag.
4. Watch.

**Note:** Each man can carry a separate item above as long as the team has all the gear.

## **Gear (C)**

**In the field, Every Marine will carry:**

1. Weapons Cleaning Gear, with CLP and Rag.

(See Weapons SOPs)

2. Two (2) Bootlaces. Uses: Binding Prisoners, Repairing Gear, Tying Tourniquet, Building Shelter, Dummy Cord for Gear, Shoelaces, Pull Line, Poncho Raft, and Carrying canteens during water resupply.

3. First Aid Kit. Minimum contents: Battle Dressing, Halazone Tablets, and Iodine Disinfectant.

4. Poncho. Uses: Rafts, Shelters, Ranger Roll, Litters, and Concealing Lights.

5. Dog Tags and ID card.

# Gear (D)

## Techniques

1. Middle Pocket on pack is reserved for 60mm mortar rounds or 7.62 belts on company movements.
2. Helmets are camouflaged with cloth strips.
3. All gear is SILENT, especially dog tags, weapons, and E-tools.
4. Butt Pack should carry fighting load. Packs should be able to be dropped and still continue mission.
5. Vertical rib of pack frame is taped with Company SOP color: ORANGE. Platoon number and name should be written on tape. This simplifies identification when packs are dropped or transported.

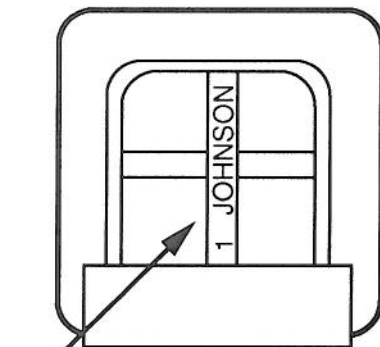

Vertical Rib with colored cloth tape,  
Platoon number and name

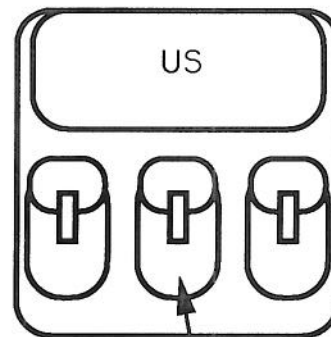

Middle Pocket reserved for  
company transport use

## **Gear (E)**

**Multiple team responsibilities  
can be assigned to the same unit.**

### **Equipment for Special Teams**

#### **Rope Team:**

Equipment for single hasty rappel line or single river crossing.

- a. 120' Kernmantle rope
- b. (2) Carabiners

#### **Demolitions Team:**

Equipment to blow tunnel entrances, blow duds in place, and take down tree for LZ.

- a. (1) demo kit with (3) blocks of C-4.  
Igniters, time fuse and non-electric caps.

#### **Radiomen:**

See Company Communications SOPs

- a. Equipment for field expedient antennas.
  1. Comm Wire, Wire Clippers (Fingernail Clippers are good)
  2. String
- b. Equipment to waterproof the radio.
  1. Zip-Loc bag for handset
  2. Trash Bag, Cloth tape
- c. Information equipment.
  1. Pen, Pencil, Notebook
  2. CEOI and encryption sheet
  3. Zip-Loc Bag for storage of all above items.
  4. Map

#### **Aid and Litter Team:**

- a. Equipment for field expedient stretchers.
  1. Ponchos
  2. Hand saw for cutting stretcher poles

#### **Search and POW Team:**

- a. White lens flashlight for searching
- b. Camera
- c. Prisoner Kit
  1. Cloth strips for blindfolds, gags and restraints
  2. Plastic wrist restraints
- d. Cloth Bag for collecting search items or POW items.

#### **Guide:**

- a. Masking Tape for taping grenades.

# Hand and Arm Signals I

Hand and Arm signals should be one-handed so that a man with a weapon can pass them.

FILE	Index Finger
FREEZE	Fist. When Fist comes down - unfreeze. Keep fist up for as long as freeze lasts.
HALT	Palm Out: Patrol gets down for substantial halt. No signal for brief stops. Signal number of minutes with fingers.
LISTEN	Point to ear or cup ear.
360 PERIMETER	Hand grabs blouse in center of chest.
CIGAR-SHAPED PERIMETER	Hand touches mouth with thumb and index finger as if smoking.
HARBOR-STAR PERIMETER	Index finger makes circle towards sky. (Same as ASSEMBLE)
ORP	Pat Belt Buckle
DANGER AREA	Hand makes cutting motion across throat.
HASTY AMBUSH	Fist punches in direction of ambush.
ENEMY SIGHTED	Point rifle in enemy direction.
ALL CLEAR	Thumb Up. Same as ALL PRESENT, FINISHED, I UNDERSTAND, and YES. Thumb Up can be used to ask question: "Do you have all your people?" "Are you ready?" YES response is also a Thumb Up.
RECON THAT AREA	Point to eye, then point toward area.
ORDERS GROUP UP!	Pat index finger to side of nose. Orders Group is PL, APL, Guide, Element Leaders, Attachment Leaders and Radio Operator.

## Hand and Arm Signals II

ASSEMBLE

Index Finger makes circle toward sky.

PATROL LEADER UP!

Tug on collar.

APL UP!

Pat hand to opposite shoulder.

# Link Up SOP

For independent small unit actions, reconnaissance and infiltration.

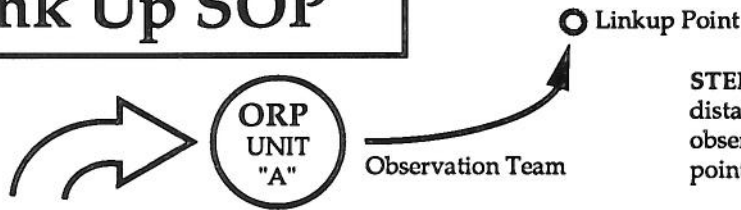

**STEP 1.** Unit "A" establishes ORP some distance from linkup point. Two-man observation team moves to exact linkup point.



**STEP 2.** Observation Team constructs symbol "Q". Tail of "Q" points 270° magnetic or *nearest direction where concealment is available*. Observation team hides in this concealment.

**STEP 3.** Unit "B" establishes perimeter some distance from linkup point. Two-man contact team moves to exact linkup point.

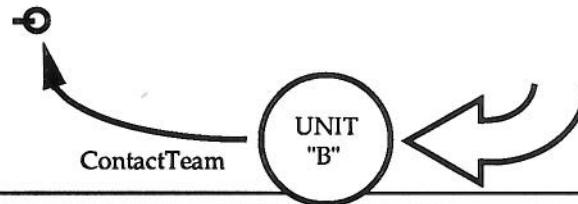

**STEP 4.** Contact Team finds "Q" symbol, faces direction of tail, and signals Observation Team: "••" "••" (YES?). Observation Team signals back: "••" (YES).

**STEP 5.** Contact Team moves to Observation team and exchanges Challenge and Password. *Both Teams* then move to Unit "B". Observation team leads Unit "B" to ORP. Linkup with Unit "A" is complete.

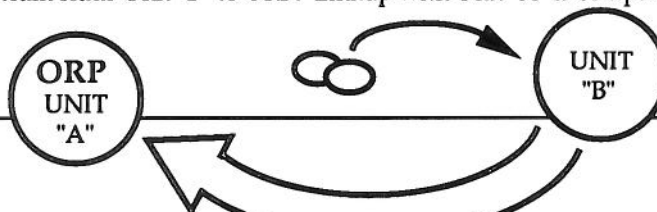

## Notes:

- Symbol "Q" can be constructed with anything available: Rope, sticks, marks in the dirt. A light stick makes an excellent "tail" for the "Q".
- Tail of "Q" should point 270° magnetic. If no concealment is available at this azimuth, Observation Team should point tail to concealment *closest to 270°*. This way, linkup can still occur even if Contact Team does not find *exact* location of "Q".
- Signal can be anything: noise, cloth or signal panel. Filtered flashlights are best at night. "YES" is two dots: "••", "NO" is one dot: "•", "ENEMY" or "DANGER" is three dots: "•••".
- Radio traffic between linking units should be avoided. Use only as last resort.
- Linkup Point is defined as a DIRECTION and a DISTANCE from a reference point. Example: "From the road junction at 695437, Linkup Point is 180m at 83° magnetic." Reference point should be easy to find at night.
- After Contact Team links up with Observation team, "Q" should be dismantled. If there are three or more units linking up, Observation Team will leave "Q" intact, and return to the linkup point *after* guiding Unit "B" to ORP.
- ORP and Linkup Point area should offer cover and concealment, multiple routes of access and escape, and be off natural lines of drift.
- Unless changed by order, linkup window will be as follows: one-third of an hour for first three hours, then one-third of an hour every three hours for three tries, then once more 24 hours later. Example: Initial linkup time is 2200. Observation team will be in place from 2200-2220, 2300-2320, 0000-0020, 0300-0320, 0600-0620, 0900-0920, and then 0900-0920 the next day.
- Alternate site should be set by time hack. Failure to linkup should be covered in GO/NO-GO criteria. If three or more units are linking, first unit at linkup point does NOT become unit "A". (How would Unit "A" know that "Q" was already in place?) Order should cover possibility of Unit "A" not showing up. Best to use a time hack.
- Enemy contact before, during or after linkup should NOT trigger alternate plan. Some units may be unaware of contact.

# Jungle Movement Technique

To move in close jungle terrain.

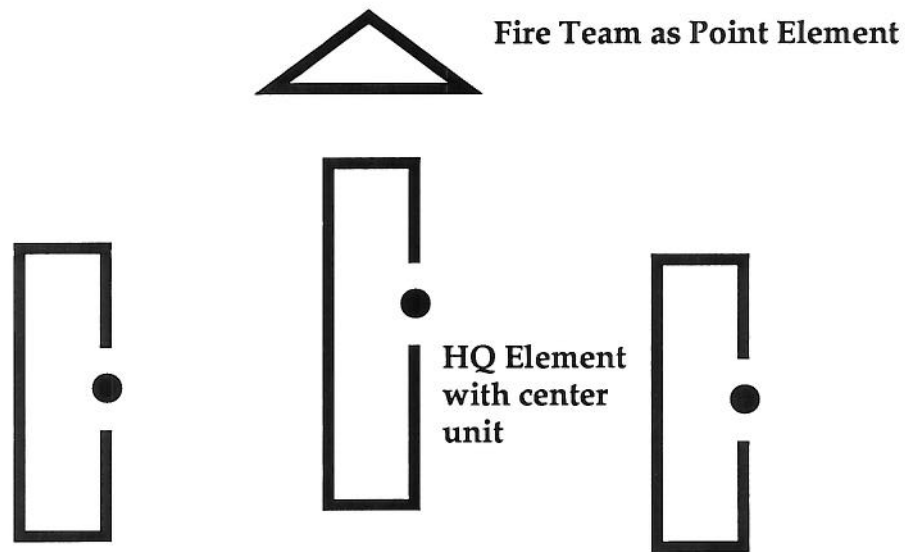

## Notes:

1. In close jungle terrain where dispersed column cannot be used, three files are used instead.
2. Each file has a compass/pace man to navigate.
3. For short halts when unit does not consolidate, flank files face outboard.
4. This technique is NOT recommended for use at night.



## Box Recon

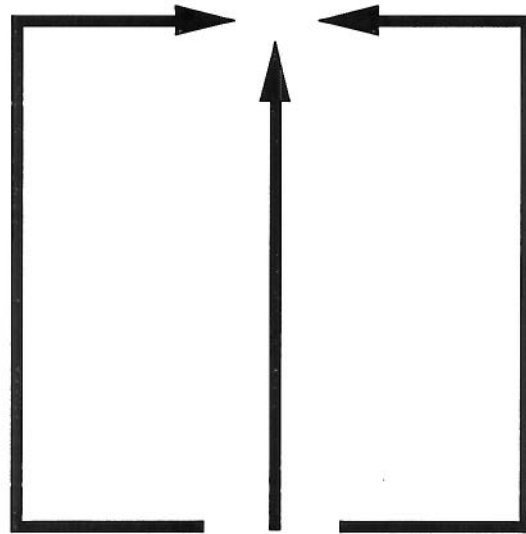

To search,  
recon,  
or clear  
a corridor in close  
terrain.

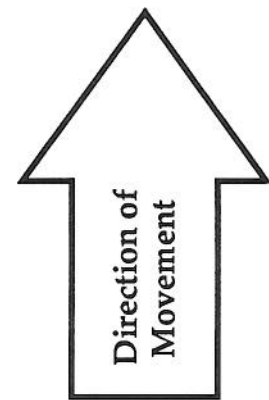

### Notes:

1. Column stops. Lead element splits into three teams, does box recon.
2. Middle and rear element follows to link up point. Elements can rotate order of movement.
3. Also used by units operating independently. A recon patrol would have no follow-on elements. A corridor would be reconned by a single element moving by successive boxex.

### Pros:

1. Security from ambush. Good technique for platoon as advance guard of company movement.
2. Good search of corridor-shaped area.
3. Faster movement than Malaysian fan technique.

### Cons:

1. Slow.

# Box Security Patrol

For short security patrols in the dark or in thick terrain.

To coordinate simultaneous patrols as in the Malaysian Fan technique.

CLOCKWISE

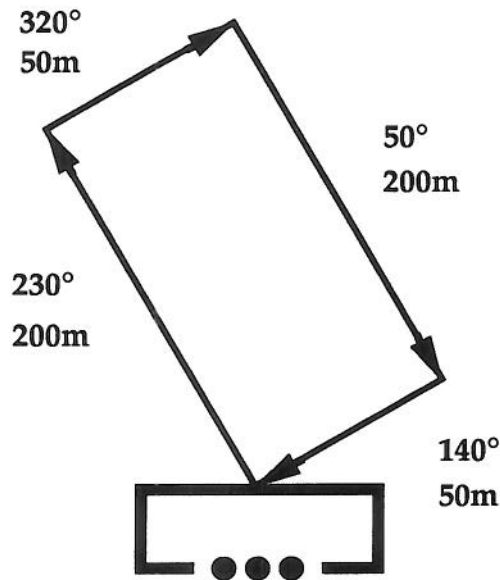

COUNTER-CLOCKWISE

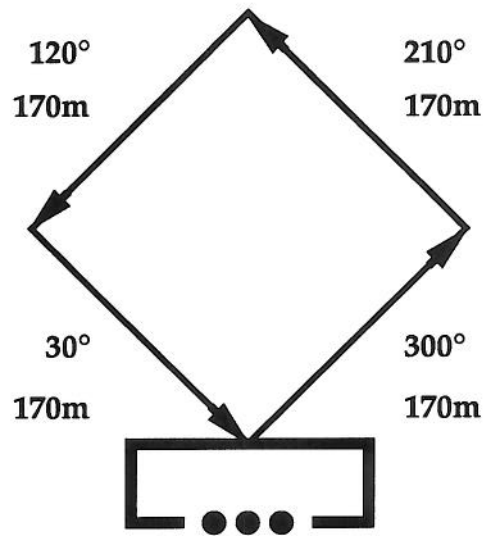

1. Order to patrol leader is simple: "Box Patrol, Clockwise, 200 by 50, Start at 230°."
2. Each corner is 90°. Patrol Leader should be able to do the addition or subtraction in his head.
3. For comm purposes, the first corner is APPLE, second is BANANA, and third is CHERRY. Patrols with radios can report positions and enemy sightings using these references.
4. All azimuths are magnetic. For simplification, use azimuths that end in zero.
5. Unless otherwise ordered, default direction is CLOCKWISE.

# Heart-Shaped Recon

To recon a circular area  
for a unit perimeter.

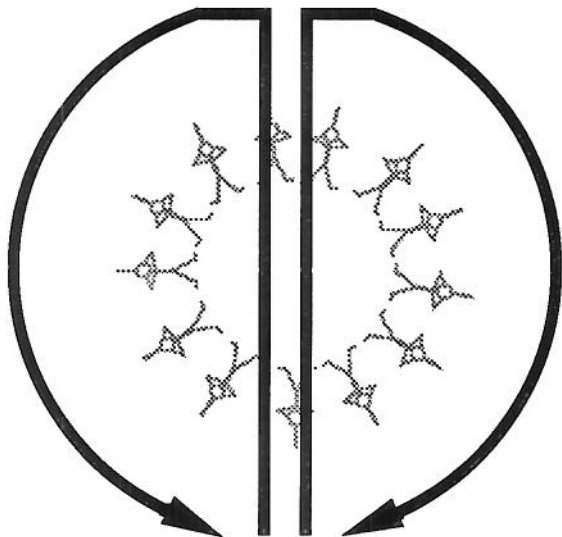

A. Heart-Shaped Recon

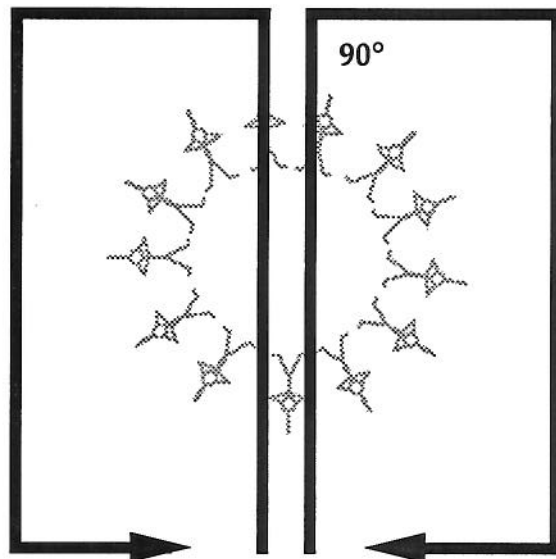

B. Box Recon

## Notes:

1. Recon team stops at 6 o'clock, signals "All Clear." Team's position defines 6 o'clock for men entering perimeter. When last man comes up, patrol is all in, recon team moves to 12 o'clock.
2. Heart-Shaped Recon and Box Recon are the same thing. A Box Recon is done using a compass and offsetting each corner 90°. This is only necessary in thick jungle or when the size of the box is quite large.
3. Depending on the terrain and the threat, the recon team can remain together for security (doing one side first, then the other), or split up.
4. The size of the area should be almost twice as large as the unit's perimeter. See imaginary unit in diagram.

# Malaysian Fan

To search,  
recon,  
or clear  
a coridor in close terrain.

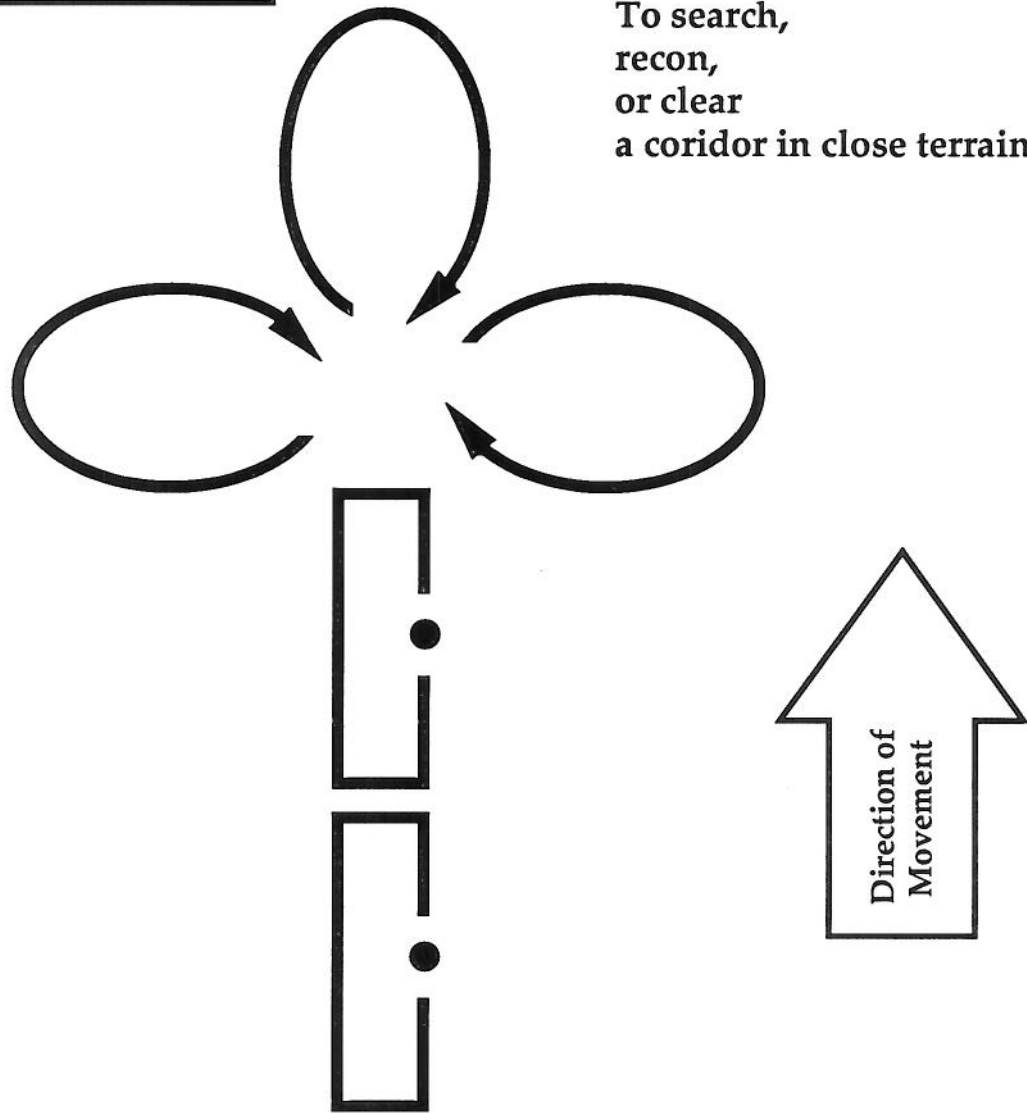

## Notes:

1. Column stops. Lead element splits into three teams, does fan-shaped recon.
2. Middle element leads off, moves short distance. Elements rotate order of movement.

## Pros:

1. Security from ambush. Good technique for platoon as advance guard of company movement.
2. Good search of coridor-shaped area.
3. On contact, quick reaction from 2nd and 3rd elements.

## Cons:

1. Slow. Real Slow.

# Zig-Zag Recon

To recon a rectangular area, typically for a patrol to move into.

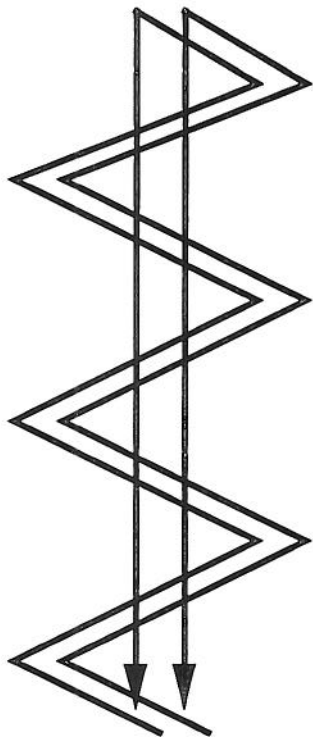

A. Team remains together

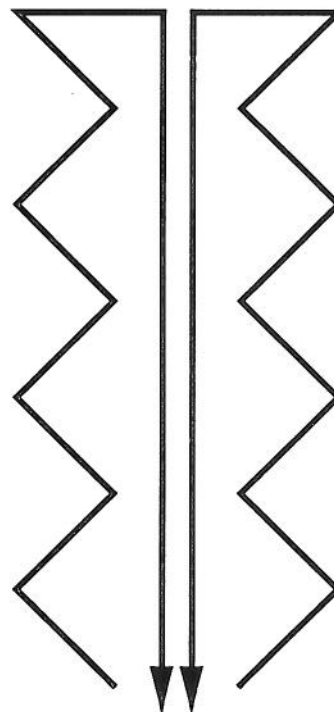

B. Team splits up



## Notes:

1. Recon team moves forward to check out area before patrol moves into it.
2. Depending on visibility and threat level, team can either remain together for security (method A), or split up (method B).
3. Usually zig-zag recon is done by first two men (point and slack) of patrol to secure far side of danger area.
4. Area searched should be same size as patrol.

## Weapons SOPs (A)

### M-16s and M-203s.

1. BZO setting will be set on the rifle at all times.
2. BZO information will be with the weapon at all times:  
Name, date fired, weapon serial number, and BZO (front sight post and windage: 4U, 4R).
3. NEVER COVER ANYTHING WITH THE MUZZLE OF THE WEAPON THAT YOU DO NOT INTEND TO DESTROY. Loaded or unloaded, blanks or live rounds - Handle the weapon as if it were loaded at all times.
4. A rifle cleaning kit, including CLP and a RAG, will be carried with the weapon at all times.
5. In the field, weapons maintenance has priority over eating, sleeping and washing. A Marine does not eat if his weapon is dirty.
6. Even on a combat patrol, the safety is on SAFE, and the trigger finger stays out of the trigger well. A negligent discharge not only gives away your position, it also kills Marines.
7. The rifle is on your body at all times except when locked in the armory and when stacked under guard.
8. 1st Marine Division SOP requires two blank rounds to be issued with each rifle during any training. Magazines will be inserted and one round will be chambered.

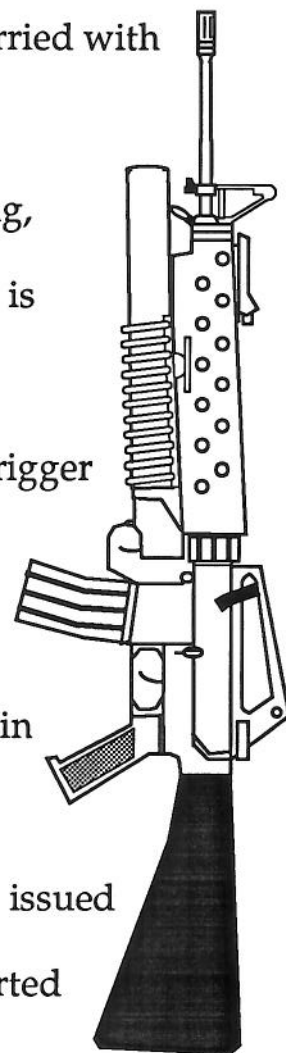

# Weapons SOPs (B)

For all Company Weapons

1. Weapons should be test-fired before going out on patrol. When a weapon is test-fired before a patrol, do not break down weapon completely during cleaning unless planning to test-fire again.

2. TEST FIRING of weapons, or expending rounds, will be conducted as a squad drill. Unit on line, one weapon type at a time, and on command of the unit leader.

3. Weapons will be silent. Squad leaders should carry tape to silence weapons.

4. In a patrol base or ORP, the priority of work is:

SECURITY

WEAPONS MAINTENANCE

PERSONAL MAINTENANCE

This means all men eating or sleeping will have already cleaned their weapon.

5. In a patrol base or ORP only one machine gun or SAW will be cleaned at any one time. Squad leaders should coordinate this with each other.

6. Weapons will be carried in the field at all times: head calls, water runs, chow. Weapons will not be left with a buddy to watch.

7. THERE IS NO SUCH THING AS AN ACCIDENTAL DISCHARGE. There are **negligent discharges**.

8. A Magazine in the well means that the weapon is **loaded**. Weapons will be loaded and unloaded as a squad drill, on command of the squad leader.

9. Belted ammunition will be stored properly for as long as possible. Exposed belts collect mud and dent rounds. Exposed belts **JAM THE WEAPON**.



# Squad Linear Ambush

EXPECTED DIRECTION OF ENEMY APPROACH

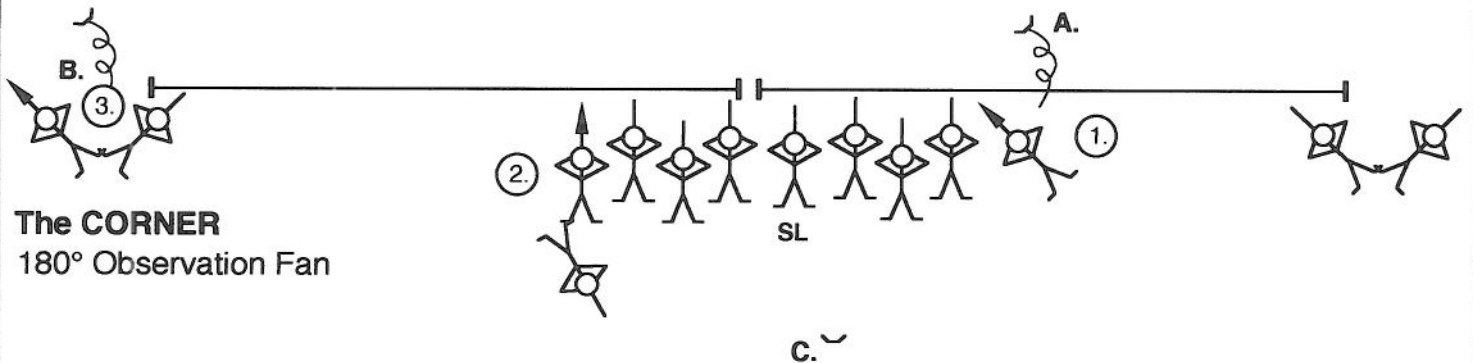

**The CORNER**  
180° Observation Fan

## PRIORITIES FOR AUTOMATIC WEAPONS

- ① Enfilade toward enemy approach
- ② Interlocking fire with ①
- ③ Isolate kill zone, cover expected direction of enemy flanking counterattack

## FLANK SECURITY

- Always BOTH directions
- Always have comm, if only a pullwire
- Distance from main body should be same as length of kill zone
- With fewer men, flanks can be one man
- THINK before disclosing flank positions by firing

## PRIORITIES FOR CLAYMORES

- A. Enfilade toward enemy approach
- B. Isolate kill zone, cover expected direction of enemy flanking counterattack
- C. Security team emplaces to cover withdrawal

## AREAS OF OBSERVATION AND RESPONSIBILITY

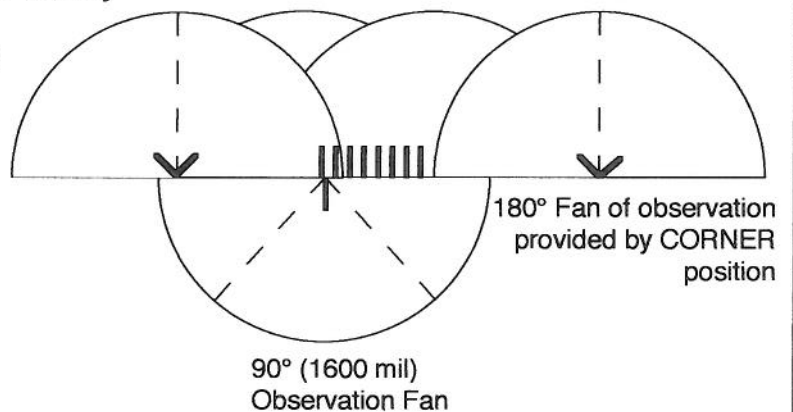

## GENERAL PRIORITIES

1. Site Selection
2. Concealment
3. Maximum Fire into Kill Zone
4. Flank Security
5. Good Route to ORP
6. Rear Security
7. Cover

## Notes:

If expected direction of enemy approach is from the right, reverse illustration. Ambush must be able to be executed regardless of direction of approach. See: **Occupation of Squad Linear Ambush** and **Execution of Squad Linear Ambush**



# Occupation of Squad Linear Ambush

1. HALT unit, establish ORP (1) terrain feature away from tentative ambush site. Squad HEDGEHOG perimeter.
2. LEADER'S RECON: SL gives 5-point contingency plan to APL (Assault Element Leader). (3) men leave on recon - SL, Security Element Leader, and Pointman. Leader's Recon selects site and returns to ORP. No one is left in ambush site. Pointman and SecEL select left and right security team positions. SL selects center point and individual positions.
3. In ORP, SL briefs movement route and information on site.
4. From ORP, squad moves out to position just short of ambush site, immediately behind left limit of ambush (not including left security position).
5. Security teams move forward. Left team hands one end of pull wire to right team, turns left and moves to position. Right team moves right to center point, ties off left team's pull wire and their pull wire, and moves to position. If squad has phones, use same procedure.
6. SL leads remainder of squad forward, turns right at left limit position, and stops at right limit position, making a big "L".

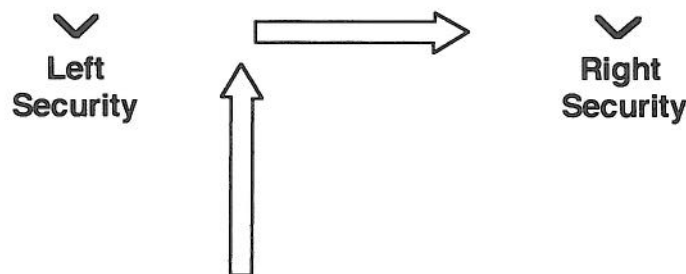

The order of march is the SAME ORDER AS OCCUPATION. Last man provides rear security. SL moves from right limit to center checking positions. If necessary, he can wait for right man to emplace claymore then move left with firing device.

7. IF MACHINE GUN TEAM IS ATTACHED: Team leader goes on Leader's Recon, selects good right limit position to enfilade toward enemy approach. Team moves behind security during movement to right limit position.
8. IF EXPECTED DIRECTION OF ENEMY APPROACH IS FROM RIGHT: Reverse above procedure. Ambush can be executed regardless of direction of approach.

# Execution of Squad Linear Ambush

FIVE SIGNALS ARE REQUIRED: WARNING  
OPEN FIRE  
CEASE FIRE  
SEARCH  
WITHDRAW

1. On enemy approach, flank sends warning. With pull wire, three dots, "..."  
means ENEMY. Response is "YES", two dots "..". SL alerts men to left and  
right. Flank sends count of enemy using dashes, "-----". Flank does  
not repeat the count. Additional count is additional enemy.
2. If SL decides to execute ambush, OPEN FIRE is passed by firing M-16 (or  
claymore if available). If ambush is discovered early, any man can initiate.  
IMMEDIATELY every man fires to maximize the shock. M-16s fire one  
magazine on BURST. Shoot low. Automatic weapons shoot ten bursts.  
Outside flank men do NOT fire. Inside flank men fire only if needed. When  
firing stops, listen for movement. SL controls additional fires. M-203  
illumination rounds can be fired during ambush, but NOT during search.
3. If required, SL orders SEARCH TEAM UP. Assault element provides Search  
team. Security remains in place as search team works. Search enemy with  
WHITE flashlights, use two-man search SOP. Vocal commands can be used.
4. When SL signals "WITHDRAW", squad withdraws in inverse order. Rear  
security man is point for ASSAULT Element, moves out in same "L" pattern  
as occupation. [See **Occupation of Squad Linear Ambush**]. SL collects pull  
wires, waits for Security teams to come in. Security element provides rear  
security. If pursued, set delayed fuze claymores, call indirect fire. Indirect fire  
can also isolate kill zone from reinforcement or escape.
5. At ORP, squad reorganizes and moves out in standard patrol order.